

# Charging cable with connector T2 Mode 3, Spirally, 6m



## General information

Part no.:	E-330151XG060B
Type vehicle side	Type 2, Type 2, AC 1-phase
Specification/Norm	IEC 61851-1

## Charging connector and charging plug

Arrangement of phases	1p+N+PE and PP+CP
Current	32A
Current control contacts	2A
Rated operating voltage	200-250V
Rated operating voltage contro	30V
Insulation voltage	500V
Mean time to failure MTTF	>10 000 connections without load
information of protection	IP44
IP-Protection	IP44

## Charging connector and charging plug

Operating temperature range	-30°C - +50°C
Charging connector VDE certifi	40038624
Plug VDE certificate no.	40038626
Proximity circuit	220 Ohm
Contact surface material	Silver plated brass
Material of enclosure	strengthened thermo-shape material
Colour vehicle side	upper part black, midsection grey aluminium, lower part black
Colour infrastructure side	upper part black, midsection grey aluminium, lower part black

## Charging cable

Charging capacity (kW)	7.4kW
Rated voltage	450/750V
Temperature resistance chargin	-40°C to +80°C
Description of the charging ca	Halogen free, flame-resistant, high mechanical resistance, very good cold flexibility, very good oil and fuel resistance, UV-, ozone resistant and weatherproof
Cross-section current-carrying	3 x 6,0mm <sup>2</sup>
Cross section signal conductor	1 x 0,50mm <sup>2</sup>
Insulation conductors	EPR (3G) EVI-2 (DIN EN 50620)
Cord length	6m
Jacket material	TPE-U (11Y) EVM-1 (n. DIN EN 50620 acc. to DIN EN 50620)
Cable colour	black
Outer diameter D	12,8 ± 0,40 mm
Minimum bending radius static	4 x D
Minimum bending radius dynamic	7,5 x D
Handling	Incorrect use caused by torsional stress together with simultaneous expansion of cable should be avoided
Standards charging cable	ISO 4982-2, DIN EN 50363-10-2, DIN EN 50267-2-1, IEC 60228, DIN EN 50620, IEC 60332-1

## Dimensional drawing

Further cable lengths and individual colour adjustment on request.  
 Passing on to third parties only with the approval of Bals Elektrotechnik GmbH & Co. KG  
 Subject to technical modifications and typographical errors  
 Only valid at the time of printing. In case of recycling, check the current version.

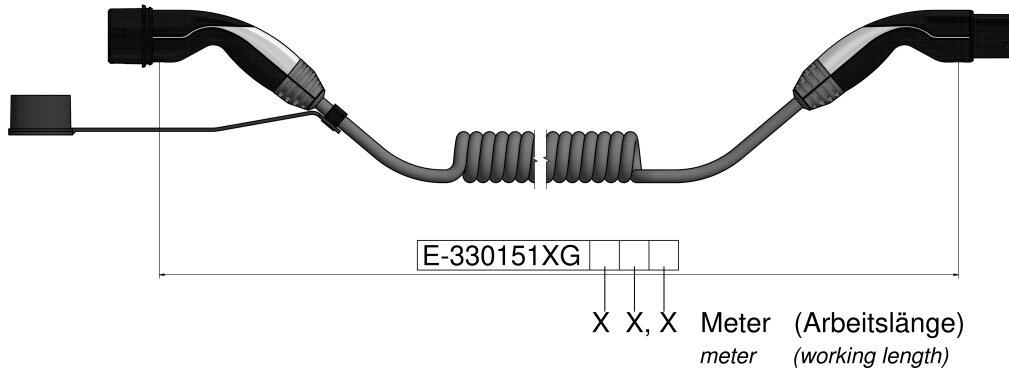

Beispiel: E-330151XG 0 5 0 = 5,0 Meter  
example: meter