

Charging socket Front mounting



Charging socket

Part no.:	E-80201-16
Protection class installed	IP20
Arrangement of phases	3p+N+PE and PP+CP
Current	20A
Current control contacts	2A
Rated operating voltage	200/346-240/415V
Rated operating voltage contro	30V
Insulation voltage	500V
Mean time to failure MTTF	>10 000 connections without load
Contact surface material	Silver plated brass
Connection design	Screw connection, conductor cross-section up to 4mm ² and 0.5mm ² for CP and PP
Material of enclosure	strengthened thermo-shape material
Colour of appliance	Enclosure black RAL 9005

Actuator - Interlocking system

Number of poles actuator	3p
Nominal voltage	12V DC
Operating voltage actuator	9V - 15,5V DC
Maximum current consumption	3,2A
No load current	≤250mA
Actuating time	200ms < t < 10s, Voltage and temperature dependent, not suitable for permanents power supply
Stability of stop position	≤6° (with short-circuited motor)
Operating temperature range	-30°C to +50°C
Life time	60,000 switching cycles in total
Assembly element	fixable push-together system
Connection for actuator	connecting cable with junction Type E-314-1000 (1000mm length – 3x0,5mm ²) - Not included in the delivery.

Connection table - Actuator

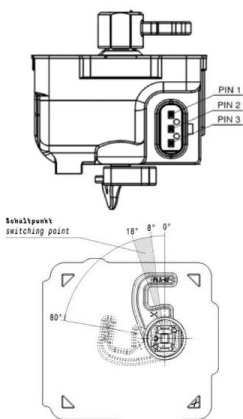

Funktion function	PIN 1	PIN 3
Entriegeln unlocking	-	+
Verriegeln interlocking	+	-

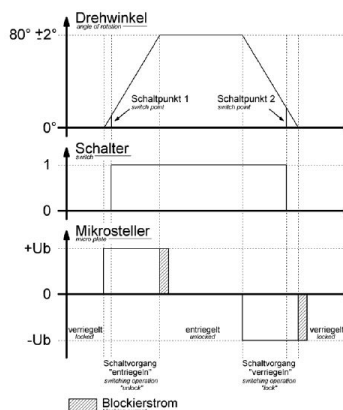
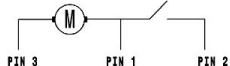

Dimensional drawing

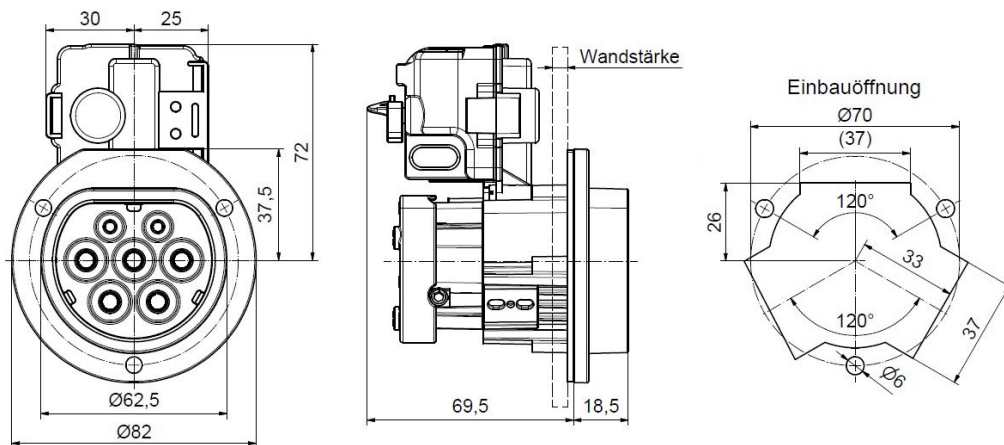

Exploded view

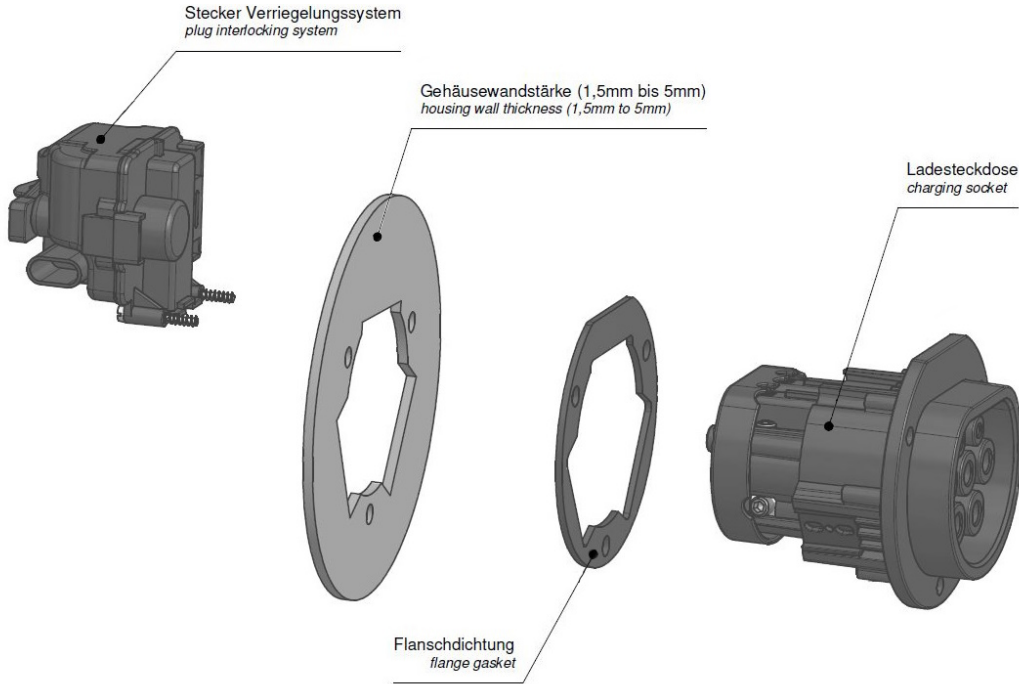

Further cable lengths and individual colour adjustment on request.
Passing on to third parties only with the approval of Bals Elektrotechnik GmbH & Co. KG
Subject to technical modifications and typographical errors
Only valid at the time of printing. In case of recycling, check the current version.