

مقبس شحن

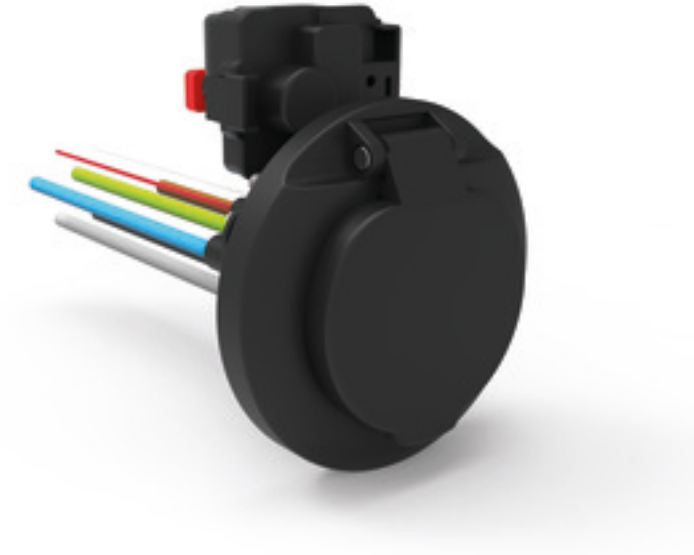

...1.

83191320700

...

,,

اللائحة المواصفة

ترتيب المراحل

20 أمبير

شدة التيار

فضة

خامة سطح التلامس

مع ملامس مزوي

تقنية التوصيل

خامة العلبة

علبة سوداء 9005

لون الأجهزة

...2.

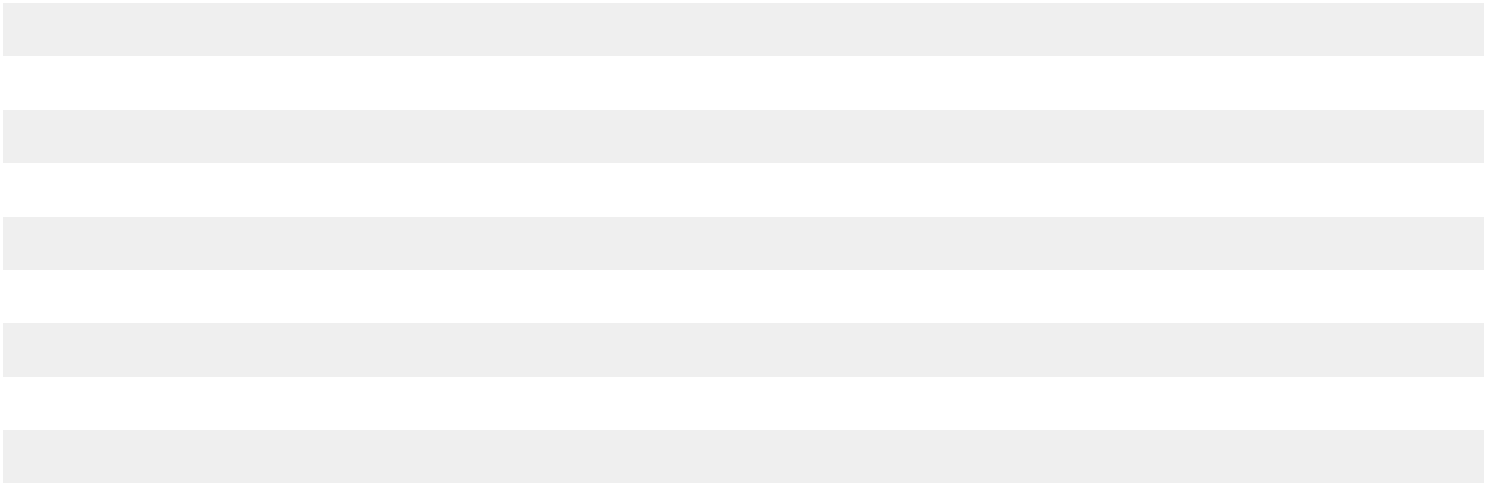

...

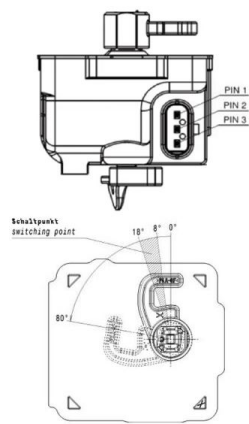

Funktion function	PIN 1	PIN 3
Entriegeln unlocking	-	+
Verriegeln relocking	+	-

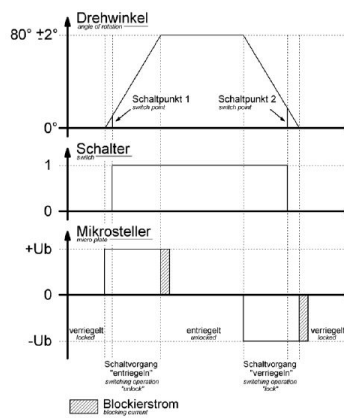
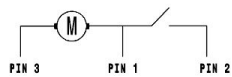

...

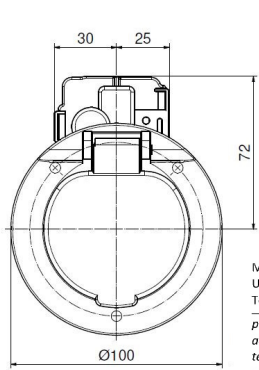

Möglichkeit zur Unterbringung eines Temperatursensors an L1  
possibility to accommodate a temperature sensor on L1

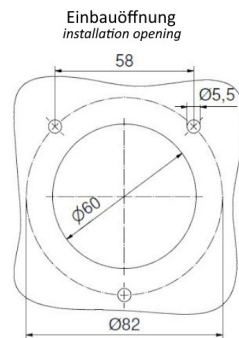
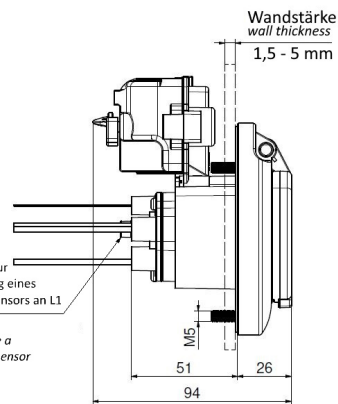

Anschluss connection	Leitungsart wire type	Querschnitt cross-section	Farbe color
L1	H07V2-K	6,0mm <sup>2</sup>	braun / brown
L2	H07V2-K	6,0mm <sup>2</sup>	schwarz / black
L3	H07V2-K	6,0mm <sup>2</sup>	grau / gray
N	H07V2-K	6,0mm <sup>2</sup>	blau / blue
PE	H07V2-K	6,0mm <sup>2</sup>	grün-gelb / green-yellow
CP	H05V2-K	0,5mm <sup>2</sup>	rot / red
PP	H05V2-K	0,5mm <sup>2</sup>	weiß / white

