

# Charging socket Front mounting



## Charging socket

Part no.:	E-83194-32A0700A
Specification/Norm	IEC 62196-1, IEC 61851-1, IEC 62196-2
Protection class installed	IP54
Arrangement of phases	3p+N+PE and PP+CP
Current	32A
Current control contacts	2A
Rated operating voltage	200/346-240/415V
Rated operating voltage contro	30V
Insulation voltage	500V
Mean time to failure MTTF	>10 000 connections without load
Contact surface material	Silver plated brass
Connection design	with crimped contacts
Material of enclosure	strengthened thermo-shape material
Colour of appliance	Enclosure black RAL 9005

## Actuator - Interlocking system

Number of poles actuator	3p
Nominal voltage	12V DC
Operating voltage actuator	9V - 15,5V DC
Maximum current consumption	3,2A
No load current	≤250mA
Actuating time	200ms < t < 10s, Voltage and temperature dependent, not suitable for permanents power supply
Stability of stop position	≤6° (with short-circuited motor)
Operating temperature range	-30°C to +50°C
Life time	60,000 switching cycles in total
Assembly element	fixable push-together system
Connection for actuator	connecting cable with junction Type E-314-1000 (1000mm length – 3x0,5mm <sup>2</sup> ) - Not included in the delivery.

## Connection table - Actuator

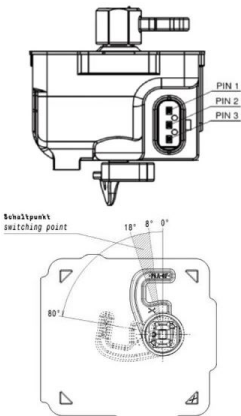

Funktion function	PIN 1	PIN 3
Entriegeln unlocking	-	+
Verriegeln interlocking	+	-

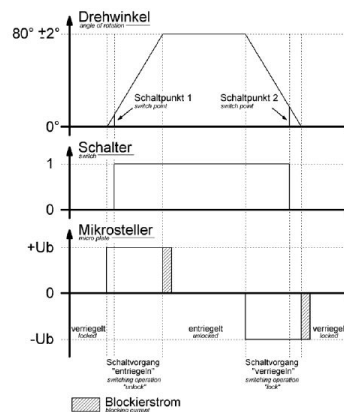
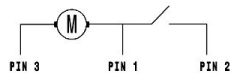

## Dimensional drawing

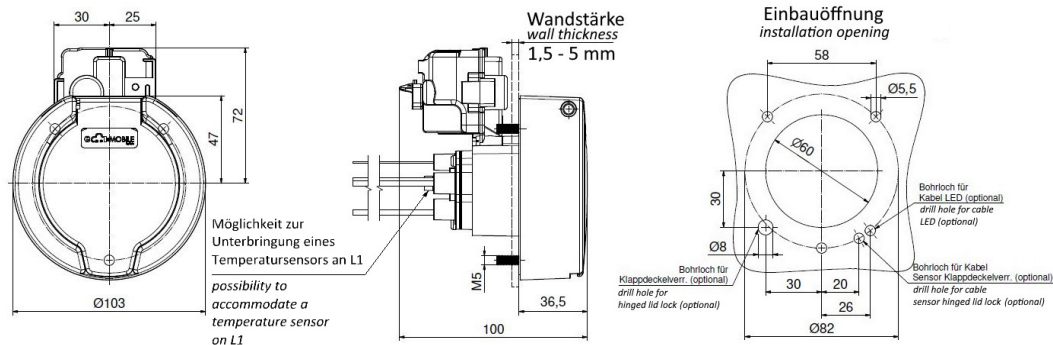

## Exploded view

Anschluss connection	Leitungsart wire type	Querschnitt cross-section	Farbe color
L1	H07V2-K	6,0mm <sup>2</sup>	braun / brown
L2	H07V2-K	6,0mm <sup>2</sup>	schwarz / black
L3	H07V2-K	6,0mm <sup>2</sup>	grau / gray
N	H07V2-K	6,0mm <sup>2</sup>	blau / blue
PE	H07V2-K	6,0mm <sup>2</sup>	grün-gelb / green-yellow
CP	H05V2-K	0,5mm <sup>2</sup>	rot / red
PP	H05V2-K	0,5mm <sup>2</sup>	weiß / white

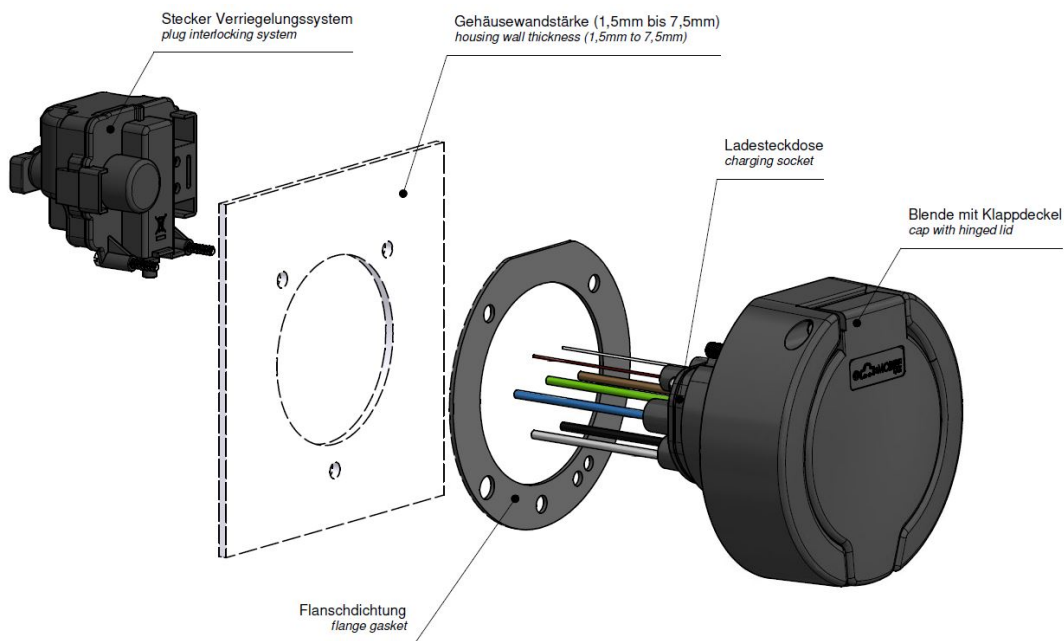
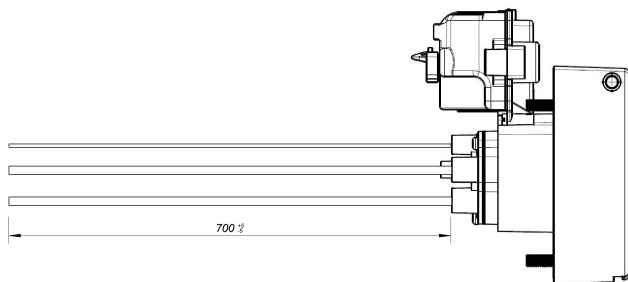

Further cable lengths and individual colour adjustment on request.

Passing on to third parties only with the approval of Bals Elektrotechnik GmbH & Co. KG

Subject to technical modifications and typographical errors

Only valid at the time of printing. In case of recycling, check the current version.