

Base null



Ladesteckdose

Bestell-Nr.:	E-83194-32E0700A
	null
Arreglo de las fases	null
Intensidad de corriente	32A
	null
	null
	null
	null
Material de la superficie del contacto	Ag
Sistema de conexión	con contacto prensado
Material de la carcasa	null
Color del equipo	Carcasa negra RAL 9005

Aktuator - Verriegelungssysteme

	null
	null
	null
	null
	null
	null
	null
	null
	null
	null

Anschlussstabelle - Aktuator

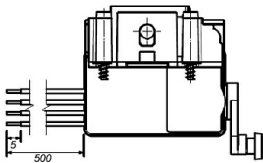

Ladesteckerverriegelung
plug interlock

Funktion function	PIN 1	PIN 4
Entriegeln unlocking	+	-
Verriegeln locking	-	+

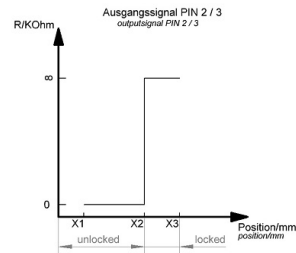
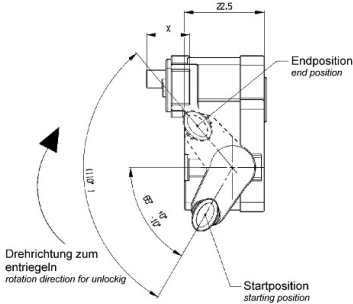
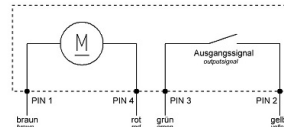

X	Status status	Position in mm position in mm
X1	nicht verriegelt unlocked	12,15 : 0,5
X2	Schaltpunkt switching point	15,60 : 0,5
X3	verriegelt locked	17,00 : 0,5

Vierleiter-Variante
four wire - variant

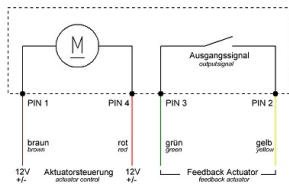

Dreileiter-Variante
three wire - variant

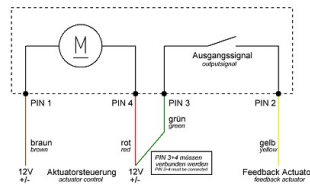

Maßbild

Anschluss connection	Leitungsart wire type	Querschnitt cross-section	Farbe color
L1	H07V2-K	6.0mm ²	braun / brown
L2	H07V2-K	6.0mm ²	schwarz / black
L3	H07V2-K	6.0mm ²	grau / grey
N	H07V2-K	6.0mm ²	blau / blue
PE	H07V2-K	6.0mm ²	grün-gelb / green-yellow
CP	H05V2-K	0.5mm ²	rot / red
PP	H05V2-K	0.5mm ²	weiß / white
Aktuator PIN1	FLRY-A	0.5mm ²	braun / brown
Aktuator PIN2	FLRY-A	0.5mm ²	gelb / yellow
Aktuator PIN3	FLRY-A	0.5mm ²	grün / green
Aktuator PIN4	FLRY-A	0.5mm ²	rot / red

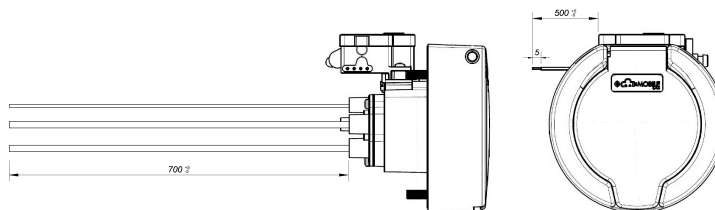

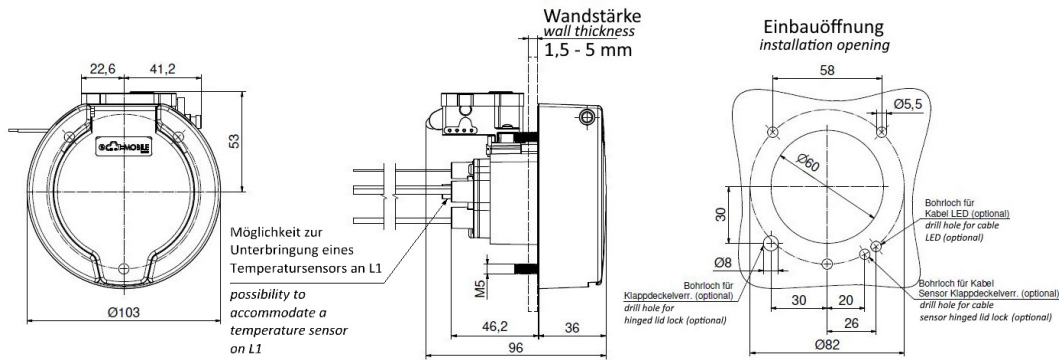

Explosionsansicht

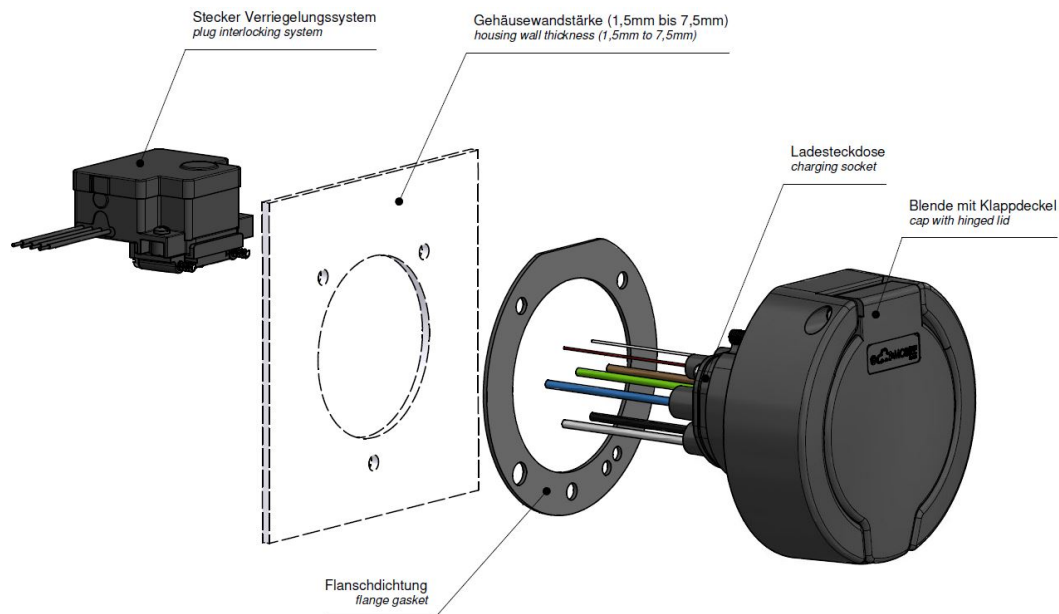

Weitere Leitungslängen und individuelle Farbgestaltung auf Anfrage.

Weitergabe an Dritte nur mit Genehmigung der Fa. Bals Elektrotechnik GmbH & Co. KG – Alle Rechte vorbehalten.

Technische Änderungen und Druckfehler vorbehalten.

Nur gültig zum Zeitpunkt des Ausdrucks. Bei Wiederverwertung prüfen Sie die aktuelle Ausführung.