

مقبس شحن

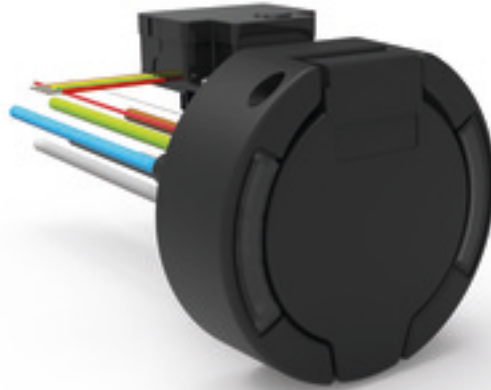

...1.

83197320700

...

ترتيب المراحل

32 أمبير

شدة التيار

فضة

خامة سطح التلامس

مع ملامس ملولب

تقنية التوصيل

خامة العلبة

علبة سوداء 9005

لون الأجهزة

...2.

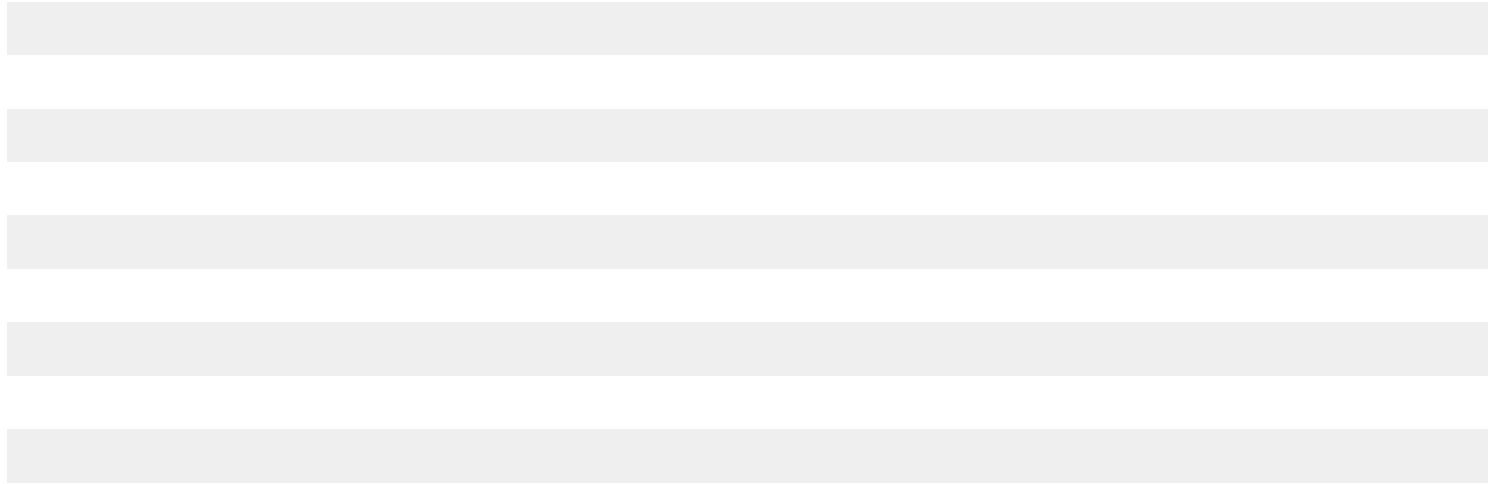

...

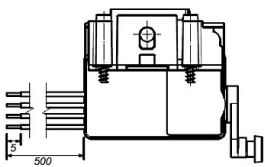

Ladesteckerverriegelung
plug interlock

Funktion function	PIN 1	PIN 4
Entriegeln unlocking	+	-
Verriegeln locking	-	+

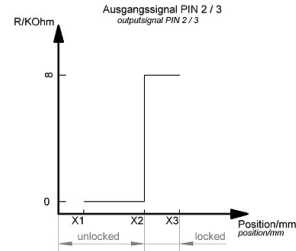
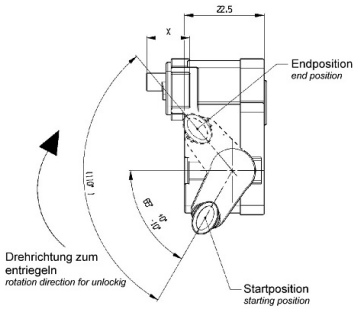
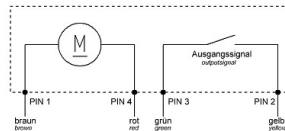

X	Status status	Position in mm position in mm
X1	nicht verriegelt unlocked	12,15 : 0,5
X2	Schaltpunkt switching point	15,60 : 0,5
X3	verriegelt locked	17,00 : 0,5

Vierleiter-Variante
four wire - variant

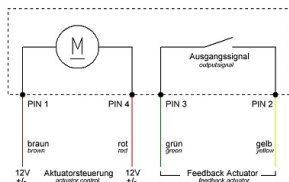

Dreileiter-Variante
three wire - variant

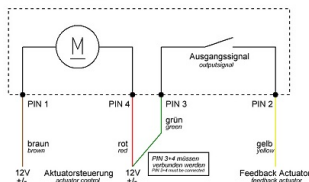

...3.

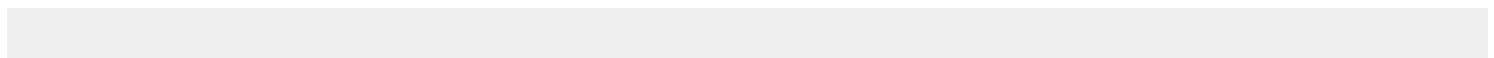

LED Beleuchtung Schaltplan
LED lightning diagram

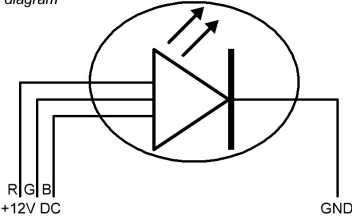

Kennzeichnung symbol	Farbe der Anschlussleitung wire color	Anschluss connection
GND	gelb yellow	Spannungsquelle GND voltage supply GND
R (+12V DC)	braun brown	RGB LED Steuerungsmodul RGB LED controller
G (+12V DC)	grün green	RGB LED Steuerungsmodul RGB LED controller
B (+12V DC)	weiß white	RGB LED Steuerungsmodul RGB LED controller

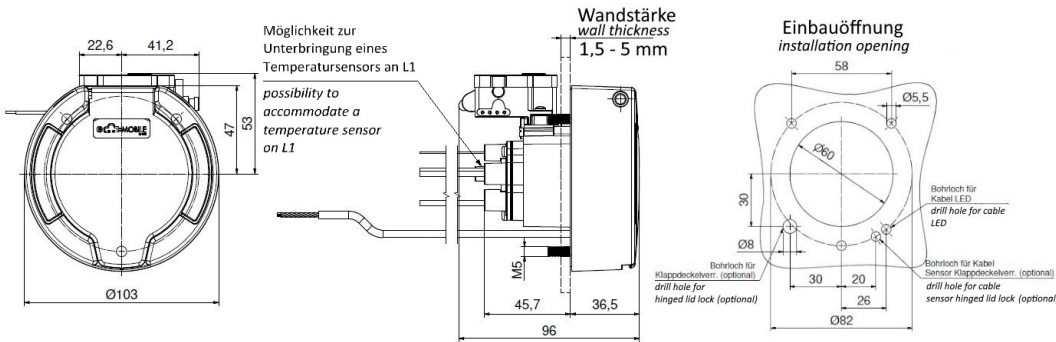

Anschluss connection	Leitungsart wire type	Querschnitt cross-section	Farbe color
L1	H07V2-K	6.0mm ²	braun / brown
L2	H07V2-K	6.0mm ²	schwarz / black
L3	H07V2-K	6.0mm ²	grau / gray
N	H07V2-K	6.0mm ²	blau / blue
PE	H07V2-K	6.0mm ²	grün-gelb / green-yellow
CP	H05V2-K	0.5mm ²	rot / red
PP	H05V2-K	0.5mm ²	weiß / white
LED - GND	LiYCY	0.14mm ²	gelb / yellow
LED R - +12VDC	LiYCY	0.14mm ²	braun / brown
LED G - +12VDC	LiYCY	0.14mm ²	grün / green
LED B - +12VDC	LiYCY	0.14mm ²	weiß / white
Aktuator PIN1	FLRY-A	0.5mm ²	braun / brown
Aktuator PIN2	FLRY-A	0.5mm ²	gelb / yellow
Aktuator PIN3	FLRY-A	0.5mm ²	grün / green
Aktuator PIN4	FLRY-A	0.5mm ²	rot / red

